

Pressure switches for gas DG..B, DG..U

OPERATING INSTRUCTIONS

Cert. Version 11.17 · Edition 11.22 · EN · 03251234



1 SAFETY

1.1 Please read and keep in a safe place



Please read through these instructions carefully before installing or operating. Following the installation, pass the instructions on to the operator. This unit must be installed and commissioned in accordance with the regulations and standards in force. These instructions can also be found at www.docuthek.com.

1.2 Explanation of symbols

1, 2, 3, a, b, c = Action

→ = Instruction

1.3 Liability

We will not be held liable for damage resulting from non-observance of the instructions and non-compliant use.

1.4 Safety instructions

Information that is relevant for safety is indicated in the instructions as follows:

⚠ DANGER

Indicates potentially fatal situations.

⚠ WARNING

Indicates possible danger to life and limb.

⚠ CAUTION

Indicates possible material damage.

All interventions may only be carried out by qualified gas technicians. Electrical interventions may only be carried out by qualified electricians.

1.5 Conversion, spare parts

All technical changes are prohibited. Only use OEM spare parts.

CONTENTS

1 Safety	1
2 Checking the usage	2
3 Installation	2
4 Wiring	3
5 Adjustment	3
6 Tightness test	4
7 Maintenance	4
8 Accessories	4
9 Technical data	6
10 Designed lifetime	7
11 Certification	7
12 Logistics	8
13 Disposal	8

2 CHECKING THE USAGE

Gas pressure switches DG for monitoring increasing and decreasing gas or air pressure.

	Positive pressure	Negative pressure
DG..B	Gas, air, flue gas	–
DG..U	Gas, air, flue gas	Air, flue gas

This function is only guaranteed when used within the specified limits – see page 6 (9 Technical data). Any other use is considered as non-compliant.

2.1 Type code

DG	Gas pressure switch
6–500	Max. setting in mbar
B	Switches with rising positive pressure
BN	Switches with falling positive pressure
U	Switches with rising positive/negative/differential pressure
UN	Switches with falling positive/negative/differential pressure
G	With gold-plated contacts
-3	Electrical connection via screw terminals
-4	Electrical connection via screw terminals, IP 65
-5	Electrical connection via 4-pin plug, without socket, IP 54
-6	Electrical connection via 4-pin plug, with socket, IP 54
-9	Electrical connection via 4-pin plug, with socket, IP 65
K2	Red/green pilot LED for 24 V DC/AC
T	Blue pilot lamp for 230 V AC
T2	Red/green pilot LED for 110 to 230 V AC
N	Blue pilot lamp for 120 V AC

2.2 Part designations

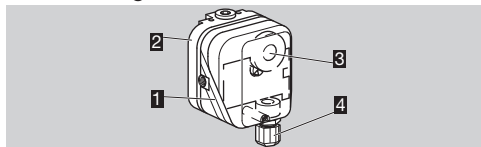

- 1 Upper housing section with cover
- 2 Lower housing section
- 3 Hand wheel
- 4 M16 cable gland

2.3 Type label

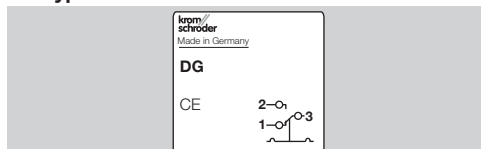

Max. inlet pressure = withstand pressure, mains voltage, ambient temperature, enclosure: see type label.

3 INSTALLATION

⚠ CAUTION

Please observe the following to ensure that the unit is not damaged during installation:

- Dropping the device can cause permanent damage. In this event, replace the entire device and associated modules before use.
- Use approved sealing material only.
- Check max. ambient temperature – see page 6 (9.1 Ambient conditions).
- Vapours containing silicone can adversely affect the functioning of electrical contacts. When using silicone tubes, only use silicone tubes which have been sufficiently cured.
- Condensation must not be allowed to get into the housing. If possible, install pipework with an ascending gradient. Otherwise, there is a risk of icing of condensation at subzero temperatures, the switching point shifting or corrosion in the device which can lead to malfunctions.
- When installing outdoors, place the pressure switch in a roofed area and protect from direct sunlight (even IP 65 version). To avoid condensation, the cover with pressure equalization element can be used. See accessories, pressure equalization element.
- Avoid strong impact on the unit.
- In case of highly fluctuating pressures, install a damping nozzle/restrictor orifice.

→ The DG must not be in contact with masonry. Minimum clearance 20 mm.

→ Ensure that there is sufficient installation space.

→ Ensure unobstructed view of the hand wheel.

3.1 Installation position

Installation in the vertical or horizontal position, or sometimes upside down, preferably with vertical diaphragm. If installed in a vertical position, the switching point p_S will correspond to the scale value SK set on the hand wheel. If installed in another position, the switching point p_S will change and no longer correspond to the set scale value SK. Switching point p_S must be checked.

$p_S = SK$	$p_S = SK + 0.18 \text{ mbar}$ (0.8 "WC)	$p_S = SK - 0.18 \text{ mbar}$ (0.8 "WC)

3.2 Connection facilities

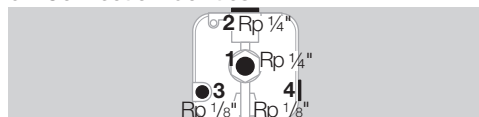

DG..U	Connect	Seal	Free
Positive pressure	1	2	3 or 4
Positive pressure	2	1	3 or 4
Negative pressure	3	4	1 or 2
Negative pressure	4	3	1 or 2
Differential pressure	1 or 2 for the higher absolute pressure. 3 or 4 for the lower absolute pressure. Seal the ports that are not in use.		

DG..B	Connect	Seal	Free
Positive pressure	1	-	-

→ If the electrical contacts in the pressure switch could be soiled by dirt particles in the surrounding air or in the medium, use a filter pad (Order No. 74916199) at ports **3** and **4**. On IP 65 units, the filter pad is fitted as standard, see type label.

3.3 Installation

- 1 Disconnect the system from the electrical power supply.
- 2 Close the gas supply.
- 3 Ensure that the pipeline is clean.
- 4 Purge the pipe.

4 WIRING

Pressure switch DG..B, DG..U can be used in Zone 1 (21) and 2 (22) hazardous areas if an isolating amplifier is installed upstream in the safe area as "Ex-i" apparatus pursuant to EN 60079-11 (VDE 0170-7):2012.

DG..B, DG..U as "simple electrical apparatus" pursuant to EN 60079-11:2012 corresponds to the Temperature class T6, Group II. The internal inductance/capacitance is $L_i = 0.2 \mu\text{H}/C_i = 8 \text{ pF}$.

In the case of low switching capacities, such as 24 V, 8 mA, for example, we recommend using an RC module (22 Ω , 1 μF) in air containing silicone or oil.

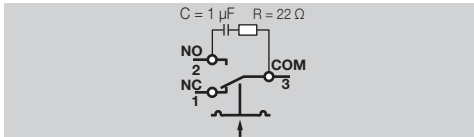

→ If the pressure switch has switched a voltage > 24 V (> 30 V) and a current > 0.1 A at $\cos \varphi = 1$ or > 0.05 A at $\cos \varphi = 0.6$ once, the gold plating on the contacts will have been burnt through. It can then only be operated at this power rating or higher power rating.

⚠ CAUTION

- To ensure that the DG..B, DG..U is not damaged during operation, note the switching capacity, see page 6 (9 Technical data).
- 1 Disconnect the system from the electrical power supply.

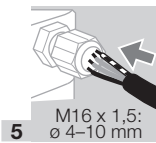
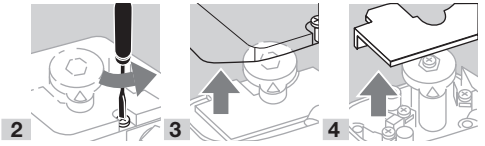

- 5 Wire as shown on the connection diagram.
 - 6 Wire as shown on the connection diagram.
 - 7 Tighten the M16 gland (1/2" NPT conduit).
- Contacts **3** and **2** close when subject to increasing pressure. Contacts **1** and **3** close when subject to falling pressure. With the NO contact, the NC contact is omitted.

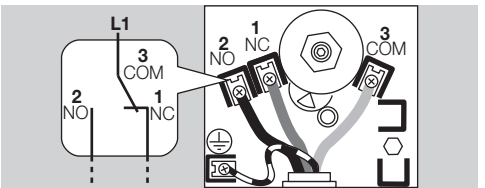

5 ADJUSTMENT

→ The switching point is adjustable via hand wheel.

- 1 Disconnect the system from the electrical power supply.
 - 2 Unscrew the housing cover.
- Once the settings have been adjusted successfully, fit the housing cover again. Note the tightening torques, see page 6 (9 Technical data).
- 3 Connect an ohmmeter.

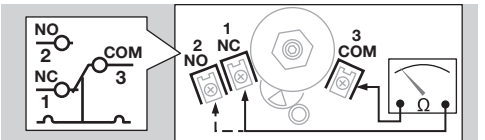

- 4 Set the switching point using the hand wheel.
- 5 Connect a pressure gauge.

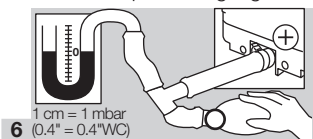

- 6
- 7 Apply pressure. In doing so, monitor the switching point on the ohmmeter and the pressure gauge.
- 8 If the DG..B, DG..U does not trip at the desired switching point, correct the adjusting range using

the hand wheel. Relieve the pressure and repeat the process.

5.1 Adjusting range

Type	Adjusting range ¹⁾ [mbar]	Switching differential ²⁾ [mbar]	Max. inlet pressure p_{max} [mbar]
DG 6	0.4–6	0.2–0.3	100
DG 10	1–10	0.25–0.4	500
DG 30	2.5–30	0.35–0.9	500
DG 50	2.5–50	0.8–1.5	500
DG 150	30–150	3–5	600
DG 400	50–400	5–15	600
DG 500	100–500	8–17	600

1) Adjusting tolerance = $\pm 15\%$ of the scale value.

2) Mean switching differential at min. and max. setting.

→ Deviation from the switching point during testing pursuant to EN 1854 Gas and air pressure switches: $\pm 15\%$. For DG 6: EN 1854 Air pressure switches: $\pm 15\%$ or ± 0.1 mbar.

6 TIGHTNESS TEST

Check all gas ports used for tightness.

1 Shut off the downstream gas pipeline close to the valve.

2 Open the valve and the gas supply.

→ $N_2 = 900$ mbar, max. 2 bar (13 psi, max. 29 psi) < 15 min.

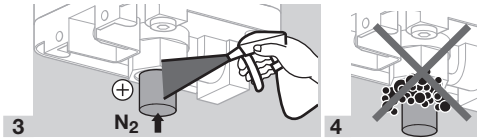

7 MAINTENANCE

In order to ensure smooth operation, check the tightness and function of the pressure switch every year, or every six months if operated with biogas.

→ A function check can be carried out in case of falling pressure monitoring e.g. with the PIA.

→ After carrying out the maintenance work, check for tightness, see page 4 (6 Tightness test).

8 ACCESSORIES

8.1 Connecting set

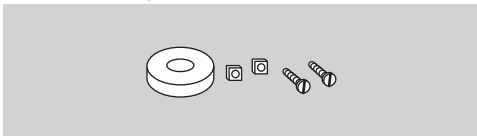

For monitoring a minimum and maximum inlet pressure with two pressure switches attached to one another. Order No.: 74912250

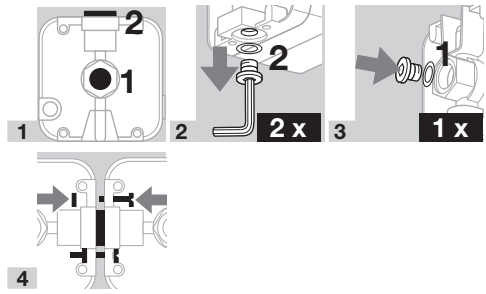

8.2 Filter pad set

To protect the electrical contacts in the DG..B, DG..U from dirt particles in the surrounding air or in the medium, use a filter pad at the 1/8" negative pressure port. As standard on IP 65 units.

5-piece filter pad set, Order No.: 74916199

8.3 External adjustment

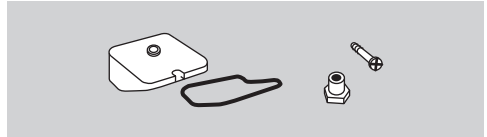

In order to set the switching pressure from the outside, the cover for external adjustment (6 mm Allen key) for DG..I can be retrofitted.

Order No.: 74916155

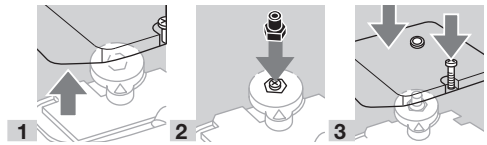

8.4 Weather protection cover

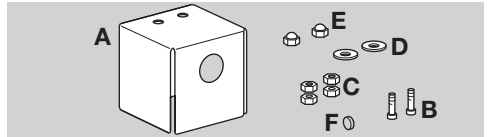

When the DG is installed outdoors, the weather protection cover provides permanent protection against condensation and weathering of housing parts.

The weather protection cover is made of 1 mm-thick stainless steel.

The enclosed filter pad is designed to protect the open 1/8" port from the ingress of dirt or insects.

Scope of delivery:

A 2 x covers, 100 x 100 x 100 mm

B 2 x M4 x 16 screws

C 4 x nuts

D 2 x washers

E 2 x cap nuts

F 1 x filter pad (1/8" port)

Order No.: 74924909

Installation position: vertical, with the cable gland pointing downwards.

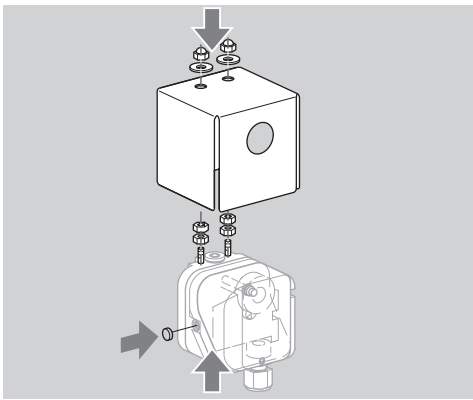

8.5 Pressure equalization element

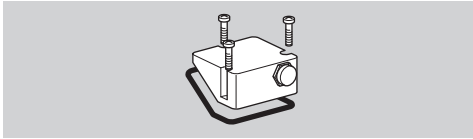

For CE certified pressure switches.
To avoid the formation of condensation, the cover with pressure equalization element can be used. The diaphragm in the screw connector is designed to ventilate the cover, without allowing water to enter.
Order No.: 74923391

8.6 Restrictor orifice

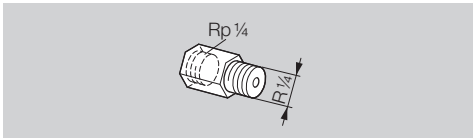

For CE certified pressure switches.
In the case of high pressure fluctuations, we recommend using a restrictor orifice (contains non-ferrous metals).
Hole diameter 0.2 mm, Order No.: 75456321
Hole diameter 0.3 mm, Order No.: 75441317

8.7 Test key PIA

To test the min. pressure switch, the DG..B, DG..U can be vented in its switched state using the PIA test key (contains non-ferrous metals).

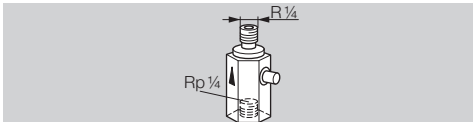

Order No.: 74329466

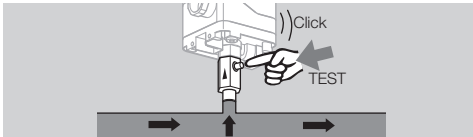

8.8 Tube set

To be used with air only.

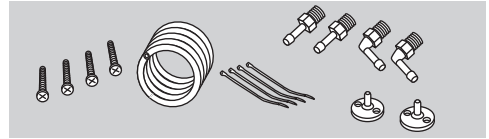

Tube set with 2 m PVC tube, 2 duct connection flanges with screws, R 1/4 and R 1/8 connecting nipples.
Order No.: 74912952.

8.9 Fastening set with screws, U-shape bracket

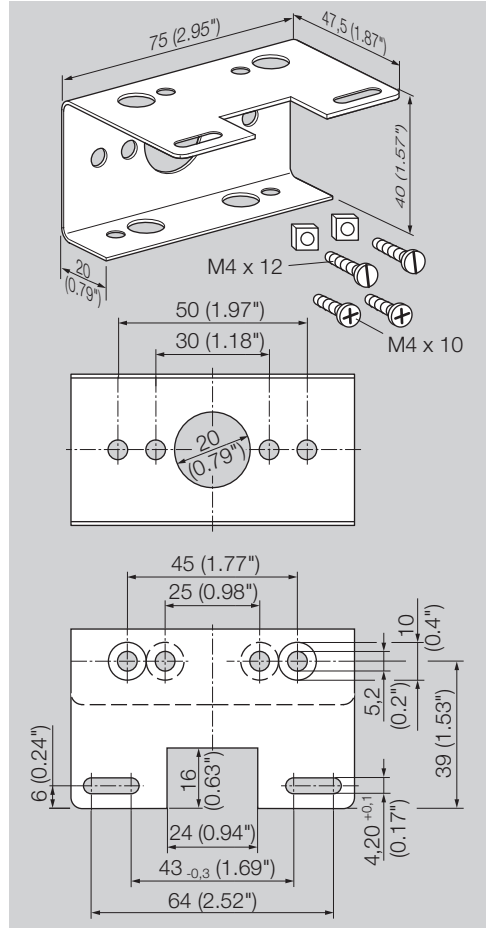

Order No.: 74915387

8.10 Standard coupler plug

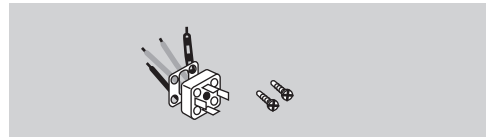

Order No.: 74920412

8.11 Standard coupler plug set

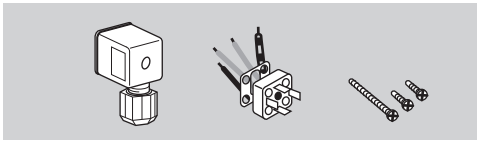

For CE certified pressure switches, Order No.: 74915388

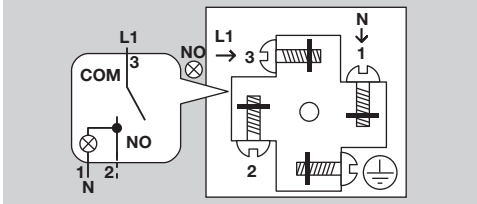

8.12 Pilot lamp, red/blue

Pilot lamp, red

110/120 V AC, I = 1.2 mA, Order No.: 74920430.

230 V AC, I = 0.6 mA, Order No.: 74920429.

Pilot lamp, blue

110/120 V AC, I = 1.2 mA, Order No.: 74916121.

230 V AC, I = 0.6 mA, Order No.: 74916122.

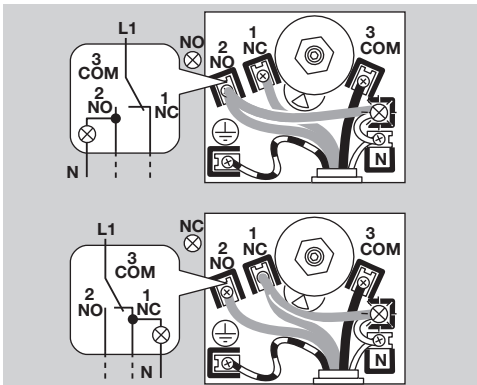
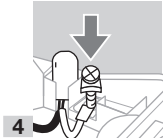
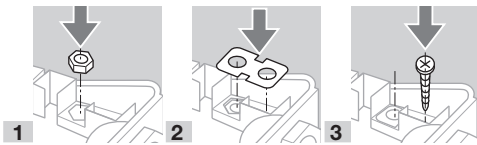
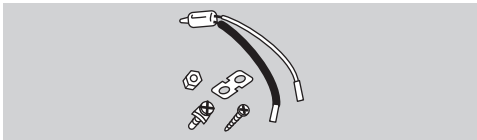

8.13 Red/green LED for 24 V DC/AC or 110–230 V AC

24 V DC, I = 16 mA; 24 V AC, I = 8 mA, Order No.: 74921089.

110 to 230 V AC, Order No.: 74923275.

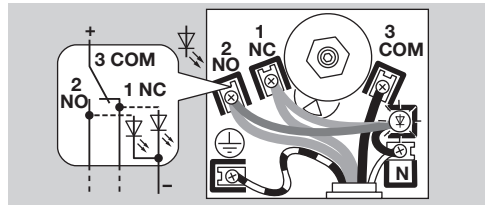
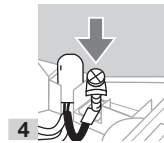
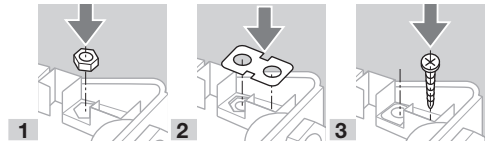
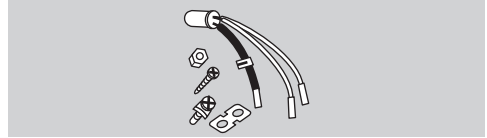

9 TECHNICAL DATA

9.1 Ambient conditions

This unit is not suitable for cleaning with a high-pressure cleaner and/or cleaning products.

Max. medium and ambient temperatures:

-20 to +80°C (-4 to +176°F).

Icing, condensation and dew in and on the unit are not permitted.

Long-term use in the upper ambient temperature range accelerates the ageing of the elastomer materials and reduces the service life (please contact manufacturer).

Enclosure: IP 54 or IP 65.

Safety class: 1.

9.2 Mechanical data

Gas type: natural gas, town gas, LPG (gaseous), flue gas, biogas (max. 0.1 %-by-vol. H₂S) and air.

Continuous operation with gases containing more than 0.1 %-by-vol. H₂S or ozone concentrations exceeding 200 µg/m³ accelerate the ageing of elastomer materials and reduce the service life.

Max. inlet pressure p_{max.} = withstand pressure, see page 4 (5.1 Adjusting range). Max. test pressure for testing the entire system: temporarily (< 15 minutes) 2 bar.

Diaphragm pressure switch, silicone-free.

Diaphragm: NBR.

Housing: glass fibre reinforced PBT plastic with low gas release, lower housing section: AlSi 12.
Weight: 270 to 320 g.

9.2.1 Recommended tightening torque

Component	Tightening torque [Ncm]
Cover screws	65
M16 x 1.5 cable gland	50
½" NPT conduit	170 (15 lb")
Rp 1/8 pipe connection on aluminium lower section	250
Rp 1/4 connection (1/4" NPT) on aluminium lower section	1300
Rp 1/8 connection on upper housing section	250
Clamping terminal screws	80
T15 test point screw	150

9.3 Electrical data

Switching capacity:

	U	I (cos φ = 1)	I (cos φ = 0.6)
DG	24–250 V AC	0.05–5 A	0.05–1 A
DG..G	5–250 V AC	0.01–5 A	0.01–1 A
DG..G	5–48 V DC	0.01–1 A	0.01–1 A

Conductor diameter: 0.5 to 1.8 mm (AWG 24 to AWG 13).

Line entrance: M16 x 1.5, clamping range: 4 to 10 mm.

Type of connection: screw terminals.

10 DESIGNED LIFETIME

This information on the designed lifetime is based on using the product in accordance with these operating instructions. Once the designed lifetime has been reached, safety-relevant products must be replaced. Designed lifetime (based on date of manufacture) in accordance with EN 13611, EN 1854 for DG..B, DG..U:

Medium	Designed lifetime	
	Switching cycles	Time (years)
Gas	50,000	10
Air	250,000	10

You can find further explanations in the applicable rules and regulations and on the afecor website (www.afecor.org).

This procedure applies to heating systems. For thermoprocessing equipment, observe local regulations.

11 CERTIFICATION

Declaration of conformity



We, the manufacturer, hereby declare that the products DG..B, DG..U with product ID No. CE- -0085AP0467 comply with the requirements of the listed Directives and Standards.

Directives:

- 2014/35/EU – LVD
- 2014/30/EU – EMC
- 2011/65/EU – RoHS II
- 2015/863/EU – RoHS III

Regulation:

- (EU) 2016/426 – GAR

Standards:

- EN 1854:2010

The relevant product corresponds to the tested type sample.

The production is subject to the surveillance procedure pursuant to Regulation (EU) 2016/426 Annex III paragraph 3.

Elster GmbH

Scan of the Declaration of conformity (D, GB) – see www.docuthek.com

11.1 UKCA certified



Gas Appliances (Product Safety and Metrology etc. (Amendment etc.) (EU Exit) Regulations 2019)
BS EN 1854:2010

11.2 SIL, PL



Safety-specific characteristic values, see Safety manual/Technical Information DG (D, GB, F) – www.docuthek.com.

11.3 AGA approval, Eurasian Customs Union, RoHS compliant



11.4 REACH Regulation

The device contains substances of very high concern which are listed in the Candidate List of the European REACH Regulation No. 1907/2006. See Reach list HTS at www.docuthek.com.

11.5 China RoHS

Directive on the restriction of the use of hazardous substances (RoHS) in China. Scan of the Disclosure Table China RoHS2, see certificates at www.docuthek.com.

12 LOGISTICS

Transport

Protect the unit from external forces (blows, shocks, vibration).

Transport temperature: see page 6 (9 Technical data).

Transport is subject to the ambient conditions described.

Report any transport damage on the unit or packaging without delay.

Check that the delivery is complete.

Storage

Storage temperature: see page 6 (9 Technical data).

Storage is subject to the ambient conditions described.

Storage time: 6 months in the original packaging before using for the first time. If stored for longer than this, the overall service life will be reduced by the corresponding amount of extra storage time.

13 DISPOSAL

Devices with electronic components:

WEEE Directive 2012/19/EU – Waste Electrical and Electronic Equipment Directive



At the end of the product life (number of operating cycles reached), dispose of the packaging and product in a corresponding recycling centre. Do not dispose of the unit with the usual domestic refuse. Do not burn the product. On request, old units may be returned carriage paid to the manufacturer in accordance with the relevant waste legislation requirements.

FOR MORE INFORMATION

The Honeywell Thermal Solutions family of products includes Honeywell Combustion Safety, Eclipse, Exothermics, Hauck, Kromschroder and Maxon. To learn more about our products, visit ThermalSolutions.honeywell.com or contact your Honeywell Sales Engineer.

Elster GmbH
Strotheweg 1, D-49504 Lotte
T +49 541 1214-0
hts.lotte@honeywell.com
www.kromschroeder.com

Global centralized service deployment coordination:
T +49 541 1214-365 or -555
hts.service.germany@honeywell.com

Translation from the German
© 2022 Elster GmbH

Honeywell
kromschroder